

**LIGHT ELECTRONICS CO., LTD.**



<b>Part No.</b>	<b>LG-IRM2A438KSF3</b>		
-----------------	------------------------	--	--

1

IRM2A438 SF3                      PIN  
 IC  
 REACH    RoHS

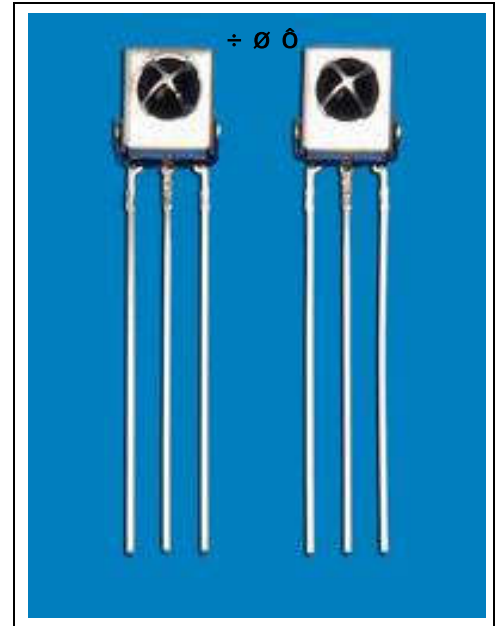

2

2.7-5.5V

3

TTL CMOS  
 :  
 (    MP3    MPã, ä å æ    ç è  
 é ê ë    ì í î    é ê í ç ì  
 ð ñ    ò

ã

ó ô :

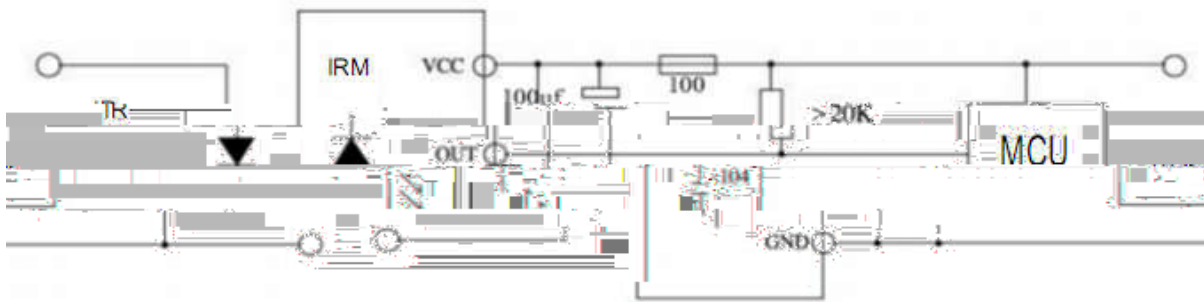

5 ó ô ô

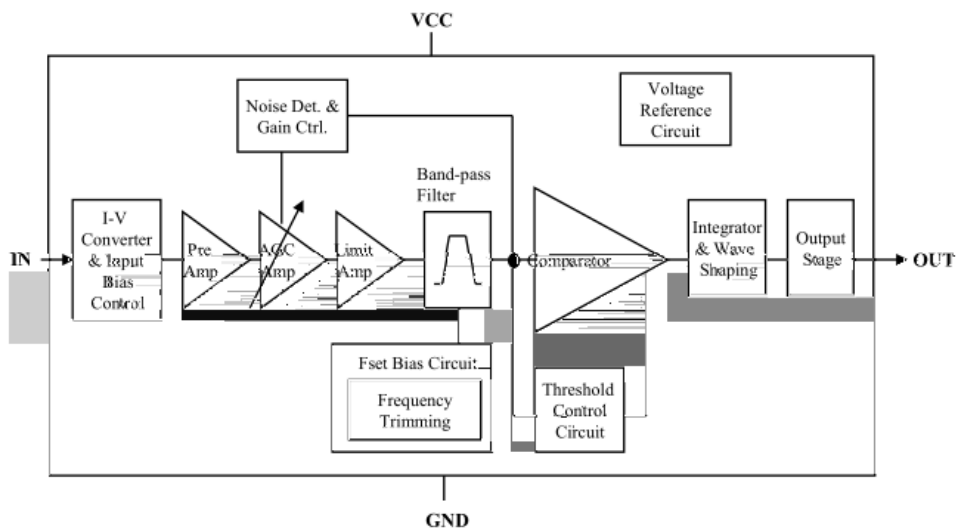

**LIGHT ELECTRONICS CO., LTD.**

L

**LIGHT ELECTRONICS CO., LTD.**

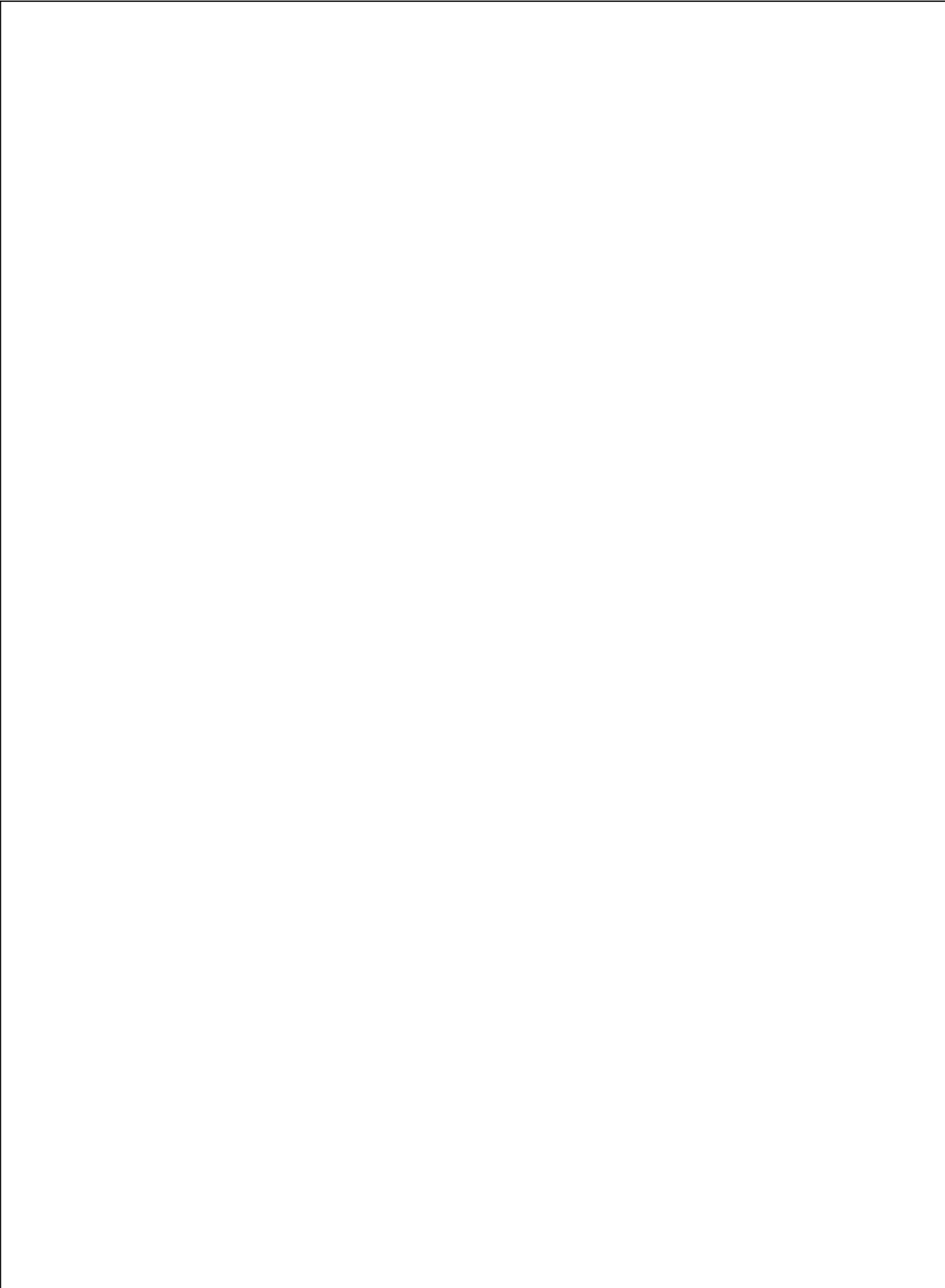

1ã

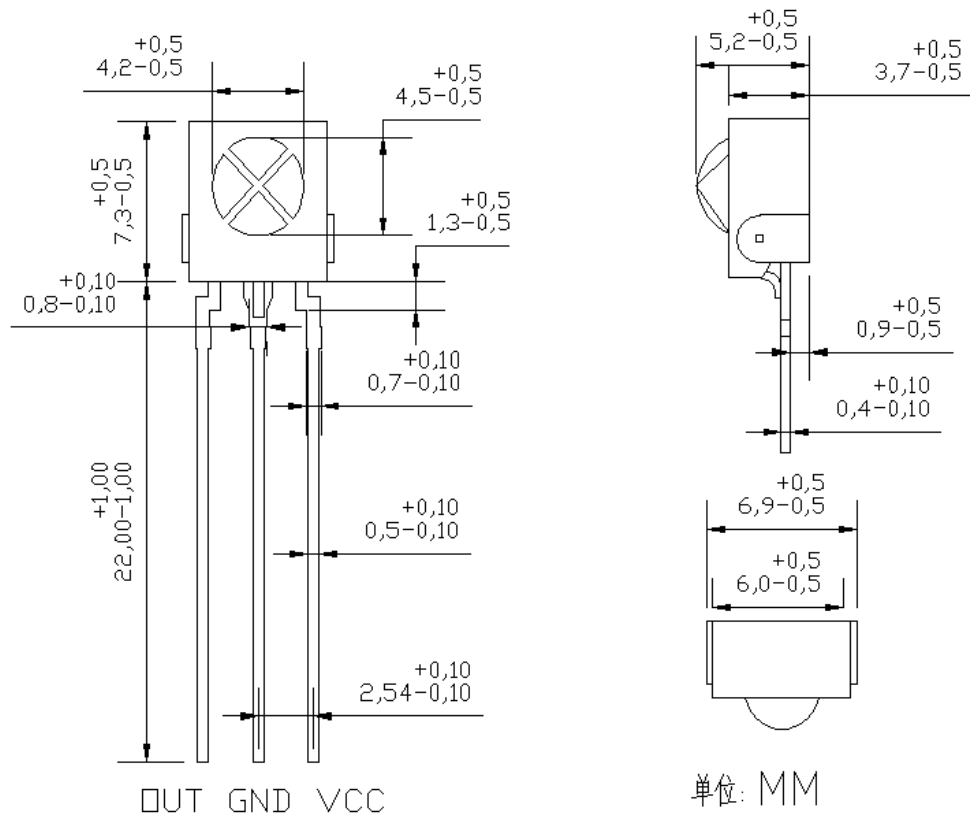

15

1è.

: 26pü 5

2

32

16.

1è.      è      ô ï

150mm× 190mm

ú      5pPCS

2è.

ô

ú      5pPCS

1p

ã

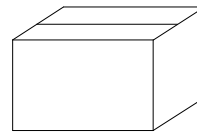
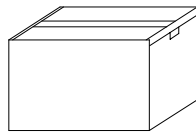
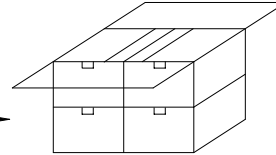
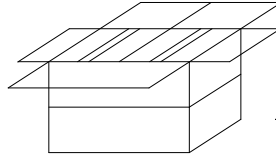
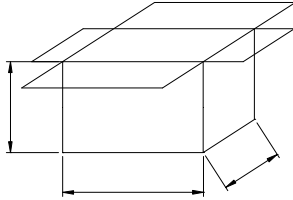
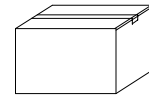
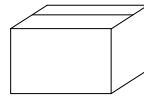
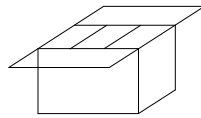
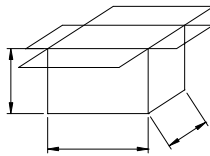
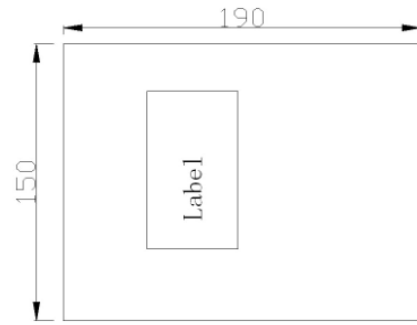

( pcs / )	( / )	( / )
<b>500</b>	<b>10</b>	<b>4</b>