

LIG

Page No. SE

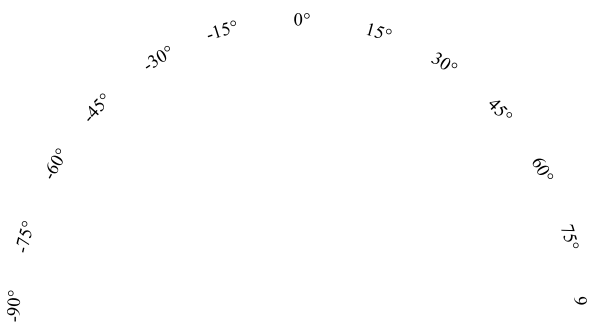

GUANGDONG SHENLITE TECHNOLOGY, INC.







Label Explanation

LIGHT Universal Label
(Reel Label)

LIGHT		
Light Electronics CO., LTD.		
MODEL NAME: _____	 <small>LOT NO. :</small>	
QUANTITY: _____		
BIN: _____		
PACKING DATE: _____		
REMARKS: _____		

Customer Defined Label
(Aluminum Moisture Proof Bag Label)

LIGHT		
Light Electronics CO., LTD.		
MODEL NAME: _____	 <small>LOT NO. :</small>	
QUANTITY: _____		
BIN: _____		
PACKING DATE: _____		
CUSTOMER P/N: _____		

Reel Dimensions

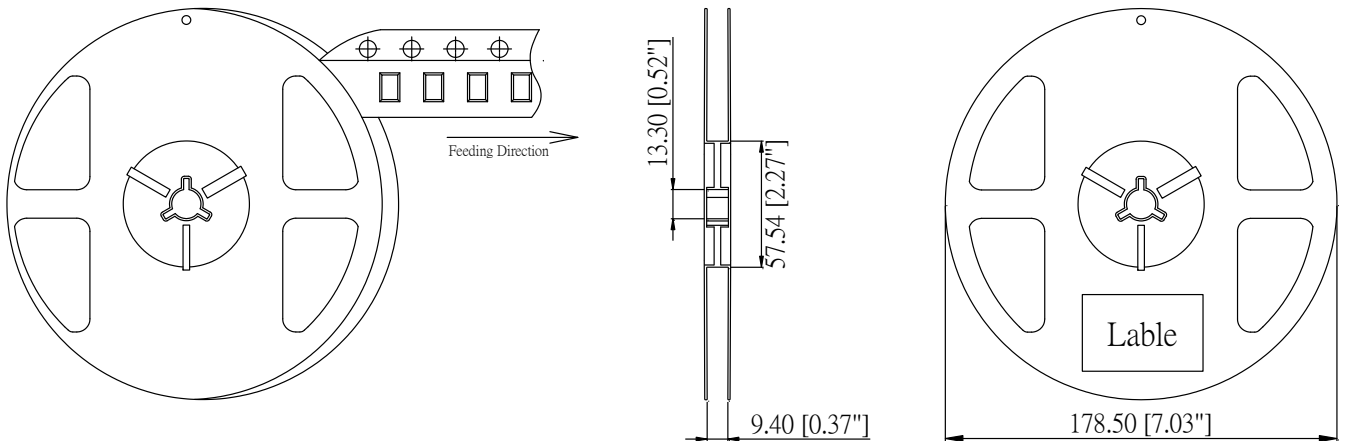

Note: Tolerance unless mentioned is $\pm 0.2\text{mm}$; Unit = mm

Carrier Tape Specifications (Loaded Quantity: 4000pcs/reel)

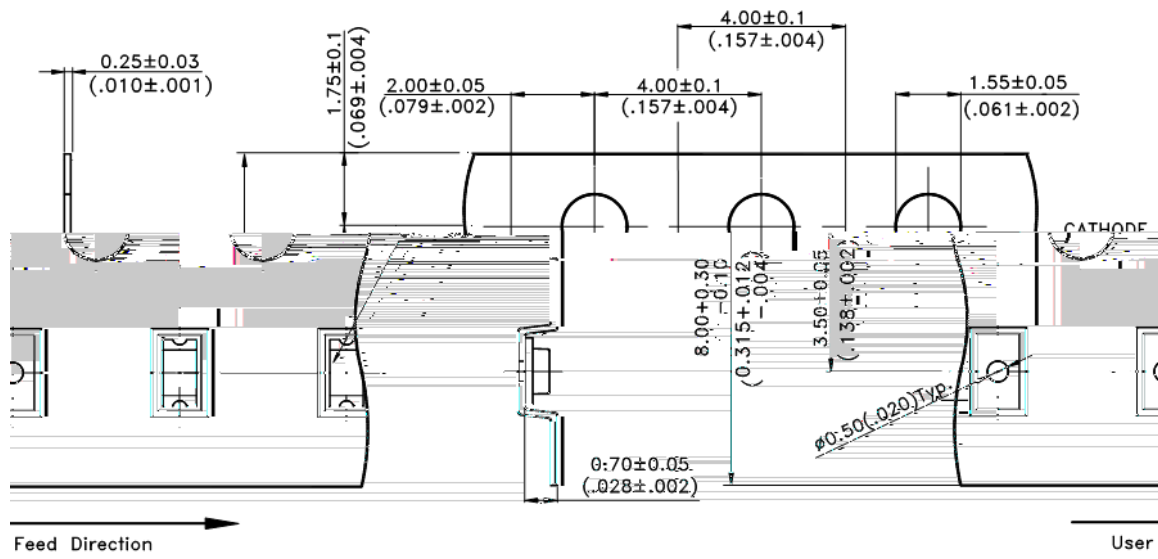

Moisture Resistant Packaging

