

## SL-T3020IRC050-L236-C-S DATA SHEET

SPEC. NO. : SZ22031001  
DATE : 2022/03/10  
REV. : A/0

Approved By:

Checked By:

Prepared By:



## Absolute Maximum Ratings at Ta=25

Parameter	MAX.	Unit
Power Dissipation	80	mW
Continuous Forward Current	50	mA
Peak Forward Current <sup>*2</sup>	500	mA
Reverse Voltage	5	V
Electrostatic Discharge (HBM) <sup>*3</sup>	4000	V
Moisture Sensitivity Level <sup>*1</sup>	4	
Operating Temperature	-40 to + 85	
Storage Temperature	-40 to + 100	
IR Reflow Temperature	260 for 10 Seconds MAX.	

**1. Storage and operating:**

## Electrical Optical Characteristics at Ta=25

Parameter	Symbol	Min.	Typ.	Max.	Unit	Test Condition
Radiant Intensity	I <sub>e</sub>	12.5	18	---	mW/sr	I <sub>F</sub> =20mA (Note 1,3)
		31	45	---	mW/sr	I <sub>F</sub> =50mA (Note 1,3)
Viewing Angle(X)	2 <sub>1/2</sub>	70	75	80	Deg.	(Note 2)
Viewing Angle(Y)		12	15	18		
Decentration angle(X)	---	---	---	±4	Deg.	---
Decentration angle(Y)	---	---	---	±3	Deg.	---
Peak Wavelength	p	---	940	---	nm	I <sub>F</sub> =50mA
Spectral Line Half- Width		---	50	---	nm	I <sub>F</sub> =50mA
Forward Voltage	V <sub>F</sub>	---	1.30	1.55	V	I <sub>F</sub> =20mA
		---	1.35	1.60	V	I <sub>F</sub> =50mA
Reverse Current	I <sub>R</sub>	---	---	5	μA	V <sub>R</sub> =5V

### Note:

1. Point sources of the amount of radiation per unit time in a given direction within the unit solid Angle radiated energy.
2. 2<sub>1/2</sub> is the off-axis angle at which the Radiant Intensity is half the axial Radiant Intensity.
3. The I<sub>e</sub> guarantee should be added ±15% tolerance.

**Typical Electrical / Optical Characteristics Curves**  
**(25 Ambient Temperature Unless Otherwise Noted)**

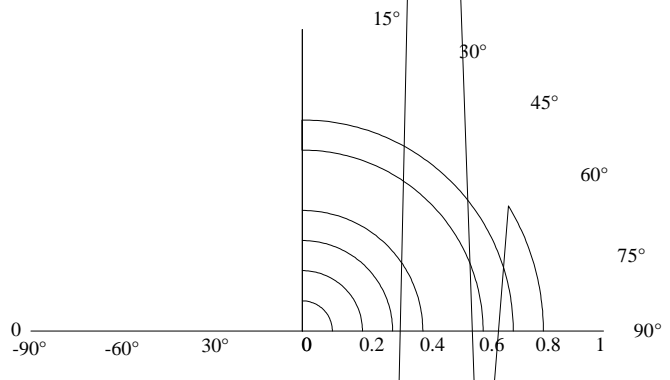
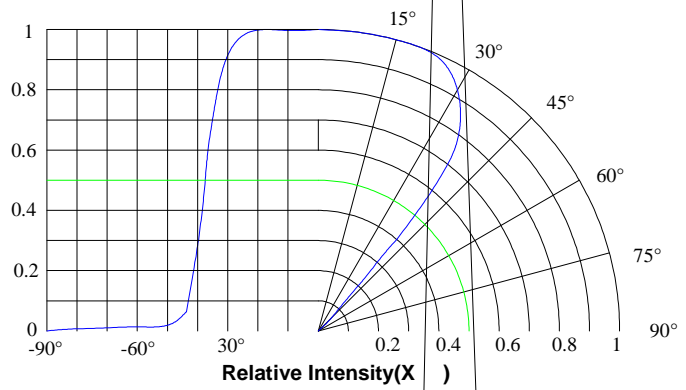
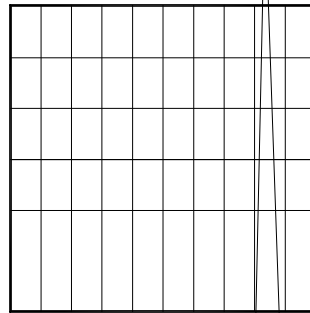
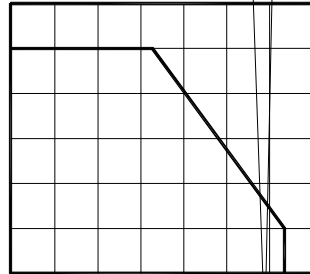
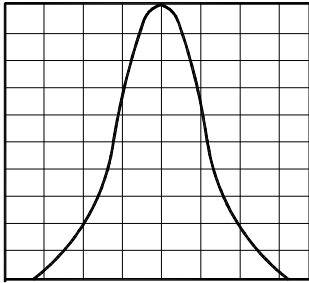

# LIGHT

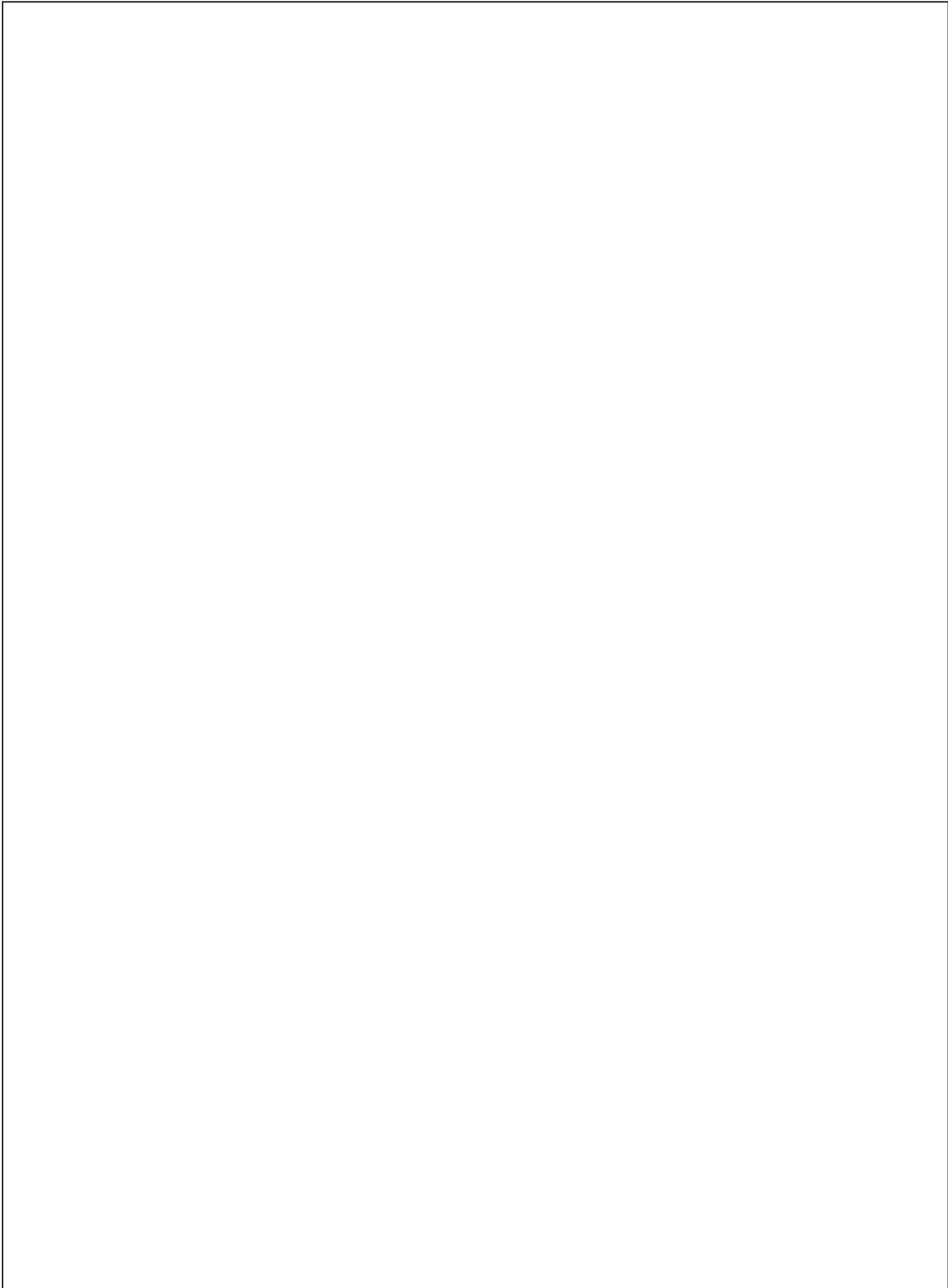

## Label Explanation

### LIGHT Universal Label

<b>LIGHT</b>		<b>RoHS</b>
Light Electronics CO., LTD		
MODEL NAME: _____	 LOT NO.: _____	
QUANTITY: _____		
BIN: _____		
PACKING DATE: _____		
REMARKS: _____		

### Customer Defined Label

<b>LIGHT</b>		<b>RoHS</b>
Light Electronics CO., LTD		
MODEL NAME: _____	 LOT NO.: _____	
QUANTITY: _____		
BIN: _____		
PACKING DATE: _____		
CUSTOMER P/N: _____		

## Reel Dimensions

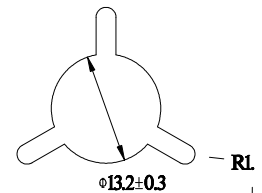
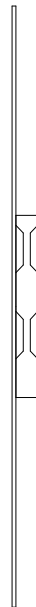
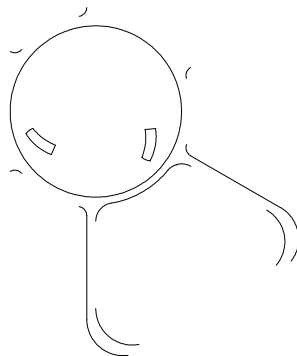

LIG

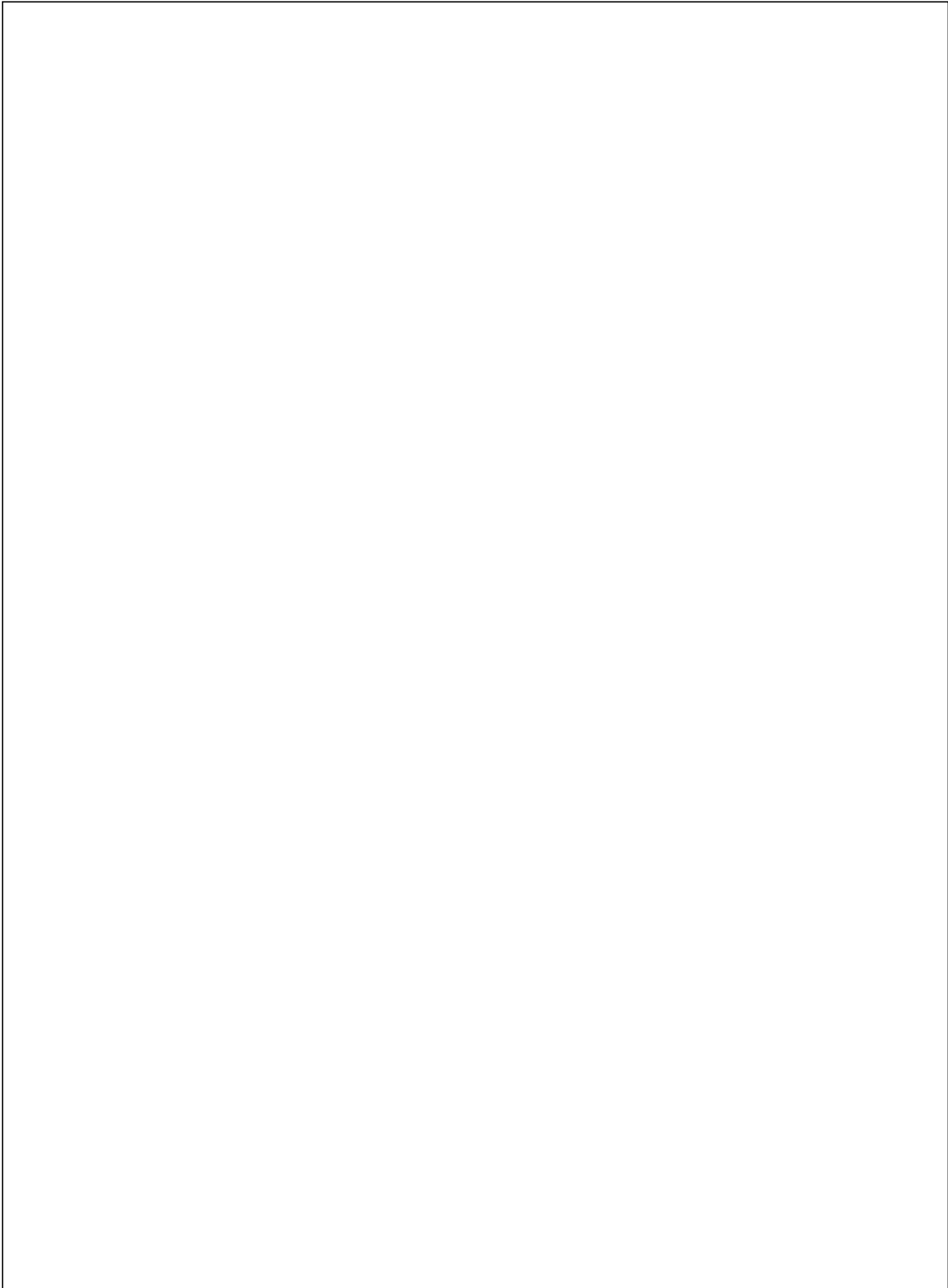

<b>Part No.</b>	<b>SL-T3020IRC050-L236-C-S</b>	<b>Page</b>	<b>8 of 9</b>
-----------------	--------------------------------	-------------	---------------



## Suggest IR Reflow Condition For Lead Free

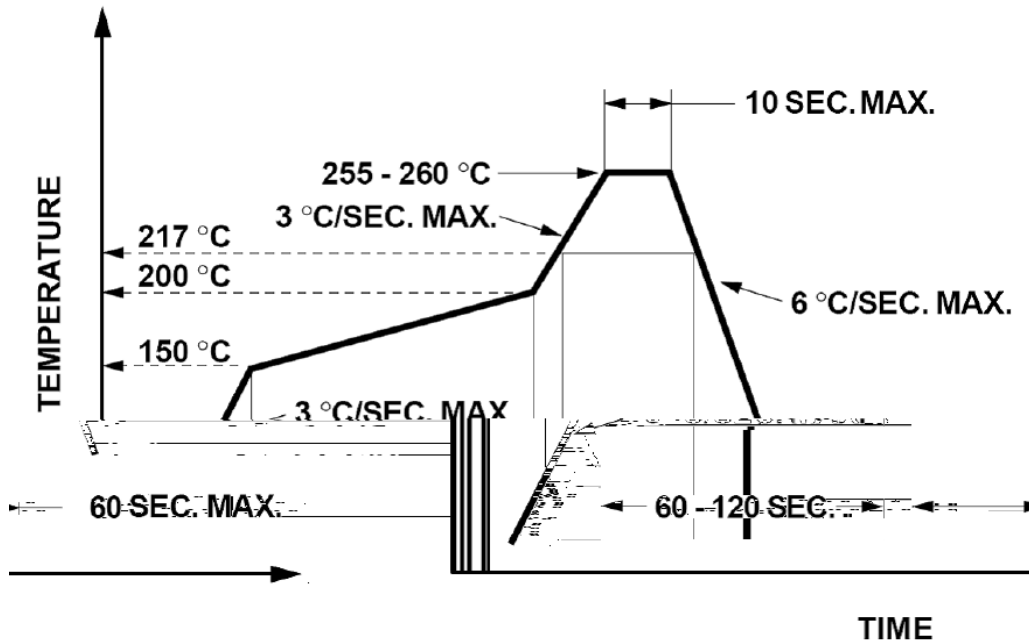

1. Reflow soldering should not be done more than two times.
2. When soldering, do not put stress on the LEDs during heating.

## Soldering iron

1. When hand soldering, the temperature of the iron must less than 300 °C for 3 seconds.
2. The hand solder should be done only once.

## Repairing

Repair should not be done after the LEDs have been soldered. When repairing is unavoidable, a double-head soldering iron should be used (as below figure). It should be confirmed beforehand whether the characteristics of LEDs will or will not be damaged by repairing.

