

□ □ □ □ □ □ □ □

□ □ □ □ □ □ □ □ □ □ □ □ □ □ □ □

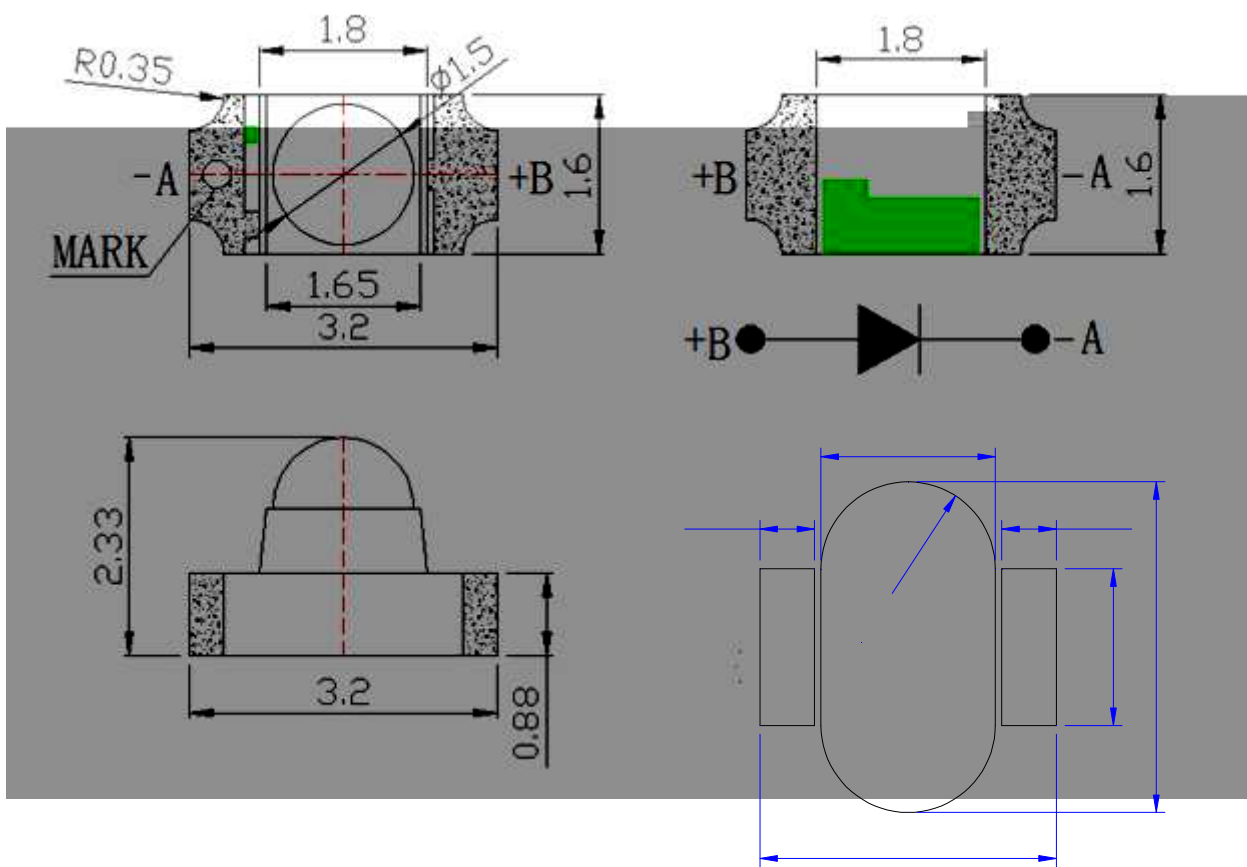

□ □ □ □ □

□ □ □ □ □ □

□ □ □ □ □ □ □ □ □ □ □ □ □ □ □ □

□ □ □ □

□ □ □ □

# LIGHT



□□□□□□□□ □□□□ □□ □□□□□□□□□□□□

□□□□□□□□

□□□□□□□□□□ □□□□□□□□□□

□□□□

□□□□

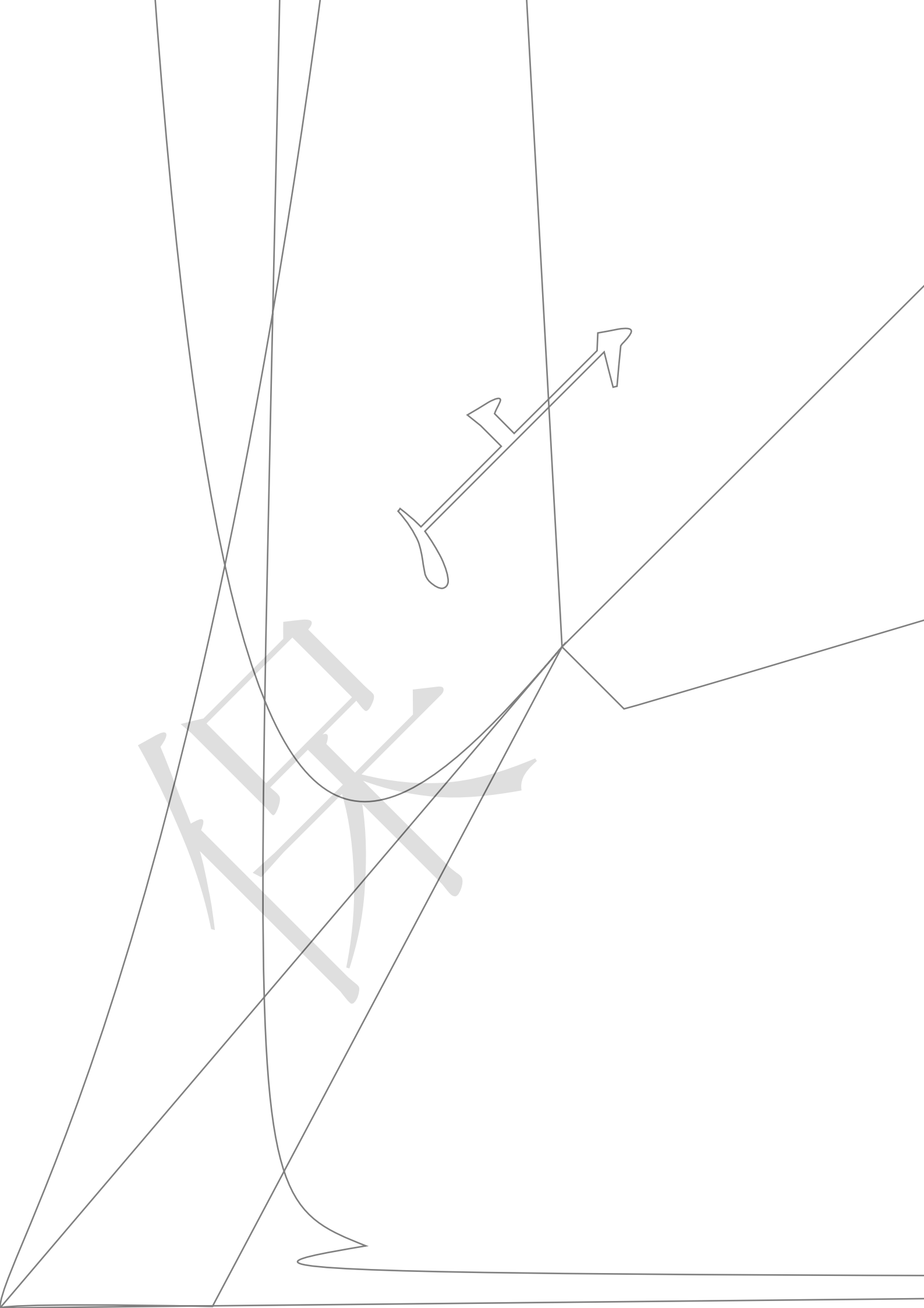

# LIGHT



□□□□□□ □□□□□□□□ □□□□□ □□□□□□□□□□ □□□□□  
 (□□ □□ □□□□□□ □□□□□□ □□□□□ □□□□ □□□□□)

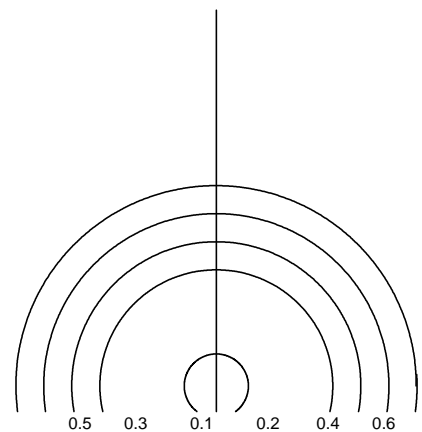
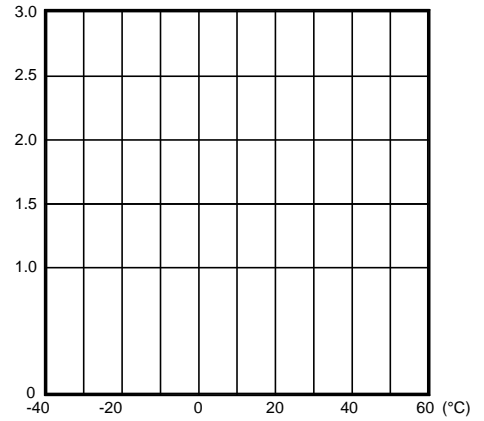
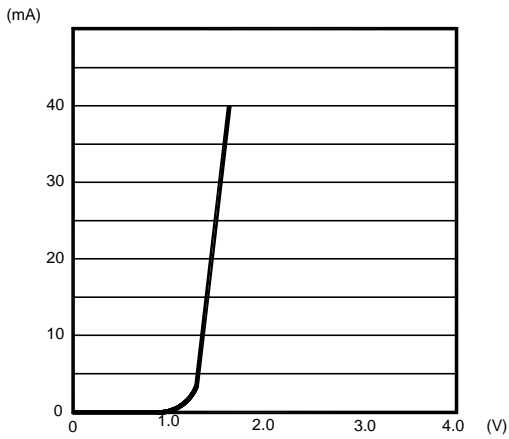
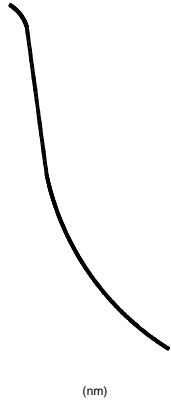



## Carrier Tape Specifications

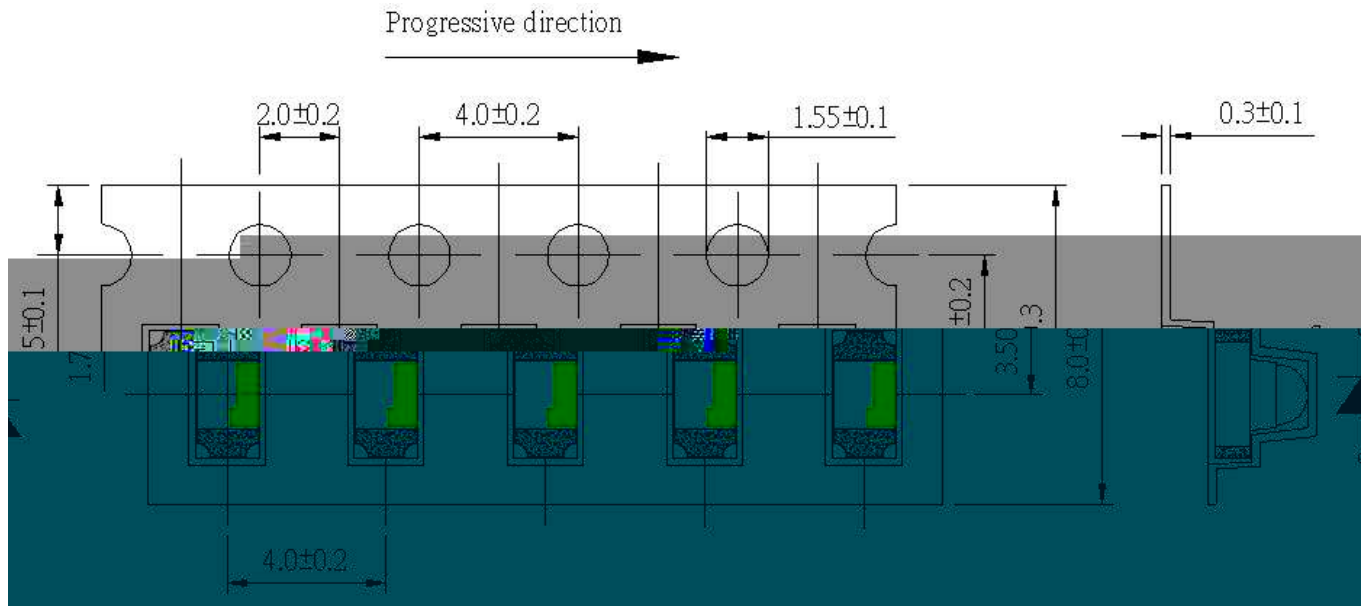

## Moisture Resistant Packaging

